

# KENDRION

---

KENDRION AUTOMOTIVE

## Adaptive suspension components

Air spring | Semi active damping

PRECISION. SAFETY. MOTION.



# Kendrion adaptive suspension components

We control and adjust your system quickly and reliably.



Improving driving comfort and increasing vehicle safety are at the core of today's development of suspensions. Flexible, adjustable dynamic systems control the vertical movement of the wheels relative to the chassis. The result is a suspension that offers a higher level of driver safety and comfort in varied driving and road conditions.

Kendrion is dedicated to meet the future needs of the market. Our products continuously adjust the suspension, stabilizing the chassis and increasing road grip and comfort. Using our modular and highly adjustable designs, car suspension manufacturers can substantially shorten design turnaround times and reduce total cost of ownership.



We find the  
best solution  
for you!



# Kendrion product scope

Our products for suspension systems guarantee the highest level of safety and comfort under different driving and road conditions.

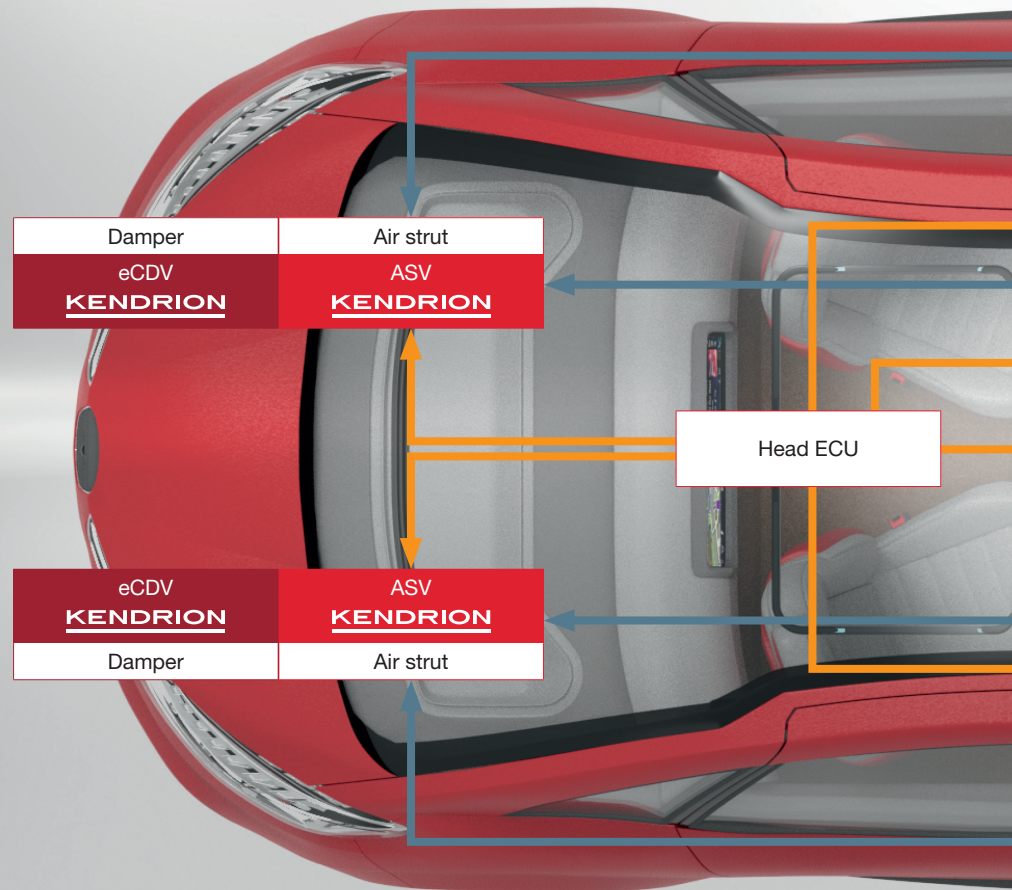



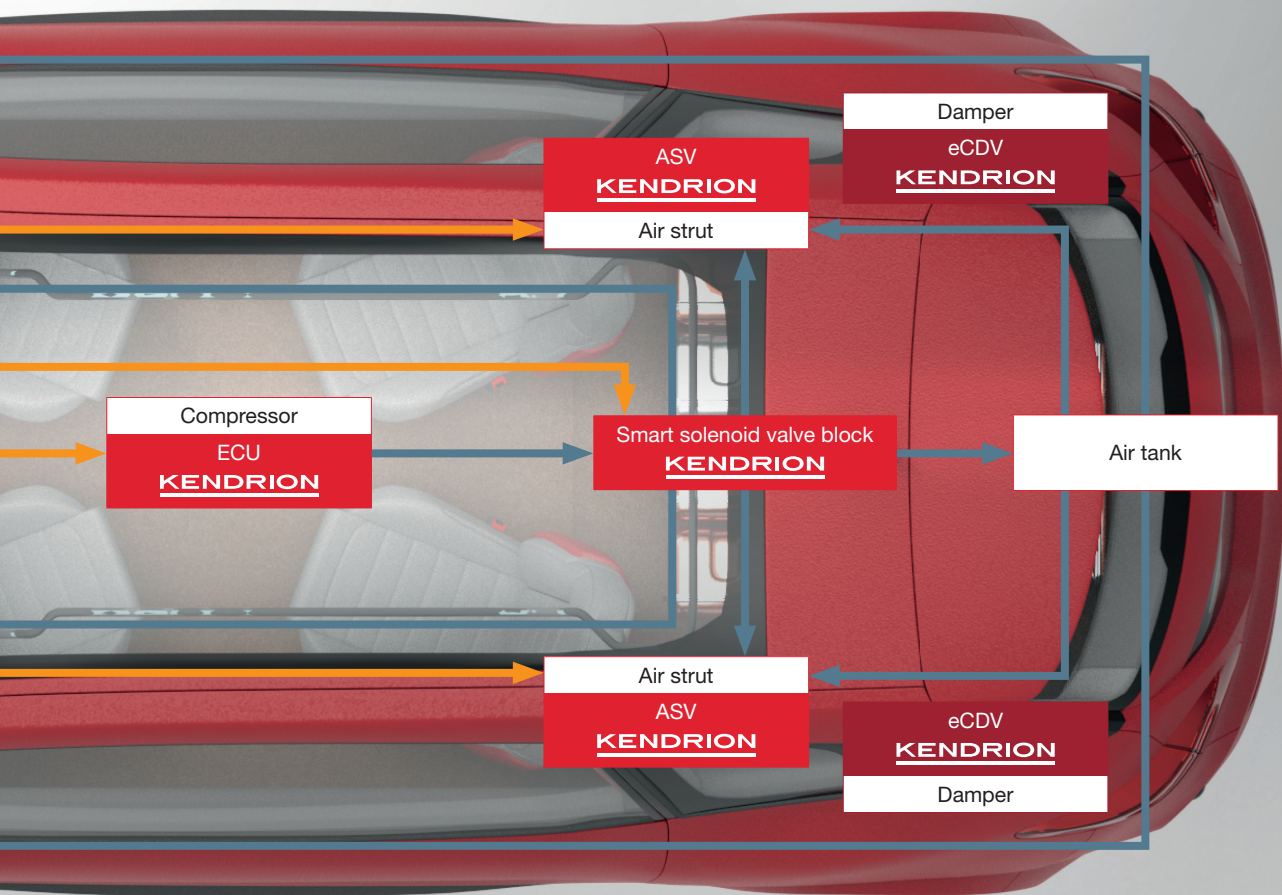

# eCDV – Active damping platform

Kendrion's brand-new product platform for external continuous damping valves (eCDVs)

## Customer benefits



### MODULAR

- » Platform design
- » Flexible: connector | PQ curve | fail-safe
- » Reduced costs

### PERFORMANCE

- » Lowest hysteresis in the market
- » Shortest design in the market





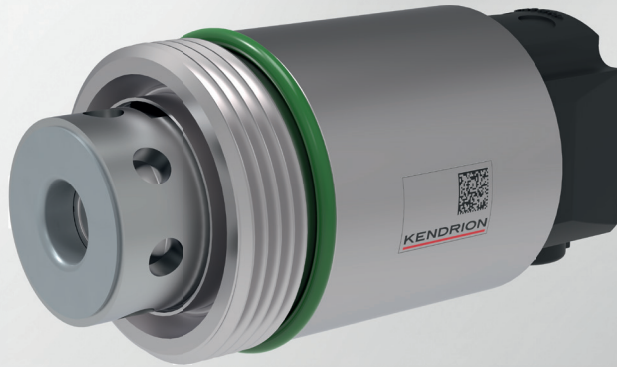

## Valves for semi-active dampers

### Driving dynamics for tomorrow's vehicles

With our eCDV we are ready for today, tomorrow and the future. We can produce multiple variants and higher volumes, more quickly and with less R&D resources. This means Kendrion can quickly provide with a proven and still customized solution.

### Technical specifications

<b>Valve type</b>	suspension valve, 2/2 proportional
<b>Valve setting</b>	comfort at low power, firm at full current
<b>Fail safe</b>	0 to 0.15 A
<b>Max. working pressure</b>	200 bar
<b>Max. pressure loss at 30 lpm</b>	6 to 8 bar
<b>Min. pressure loss at 3 lpm</b>	60 to 80 bar (adjustable)
<b>Max. flow</b>	100 lpm
<b>Nominal voltage</b>	13.5 V
<b>Control current</b>	0.4 to 1.6 A
<b>Resistance</b>	4.6 ±0,5 Ω
<b>PWM frequency</b>	1 to 2 kHz
<b>Temperature range</b>	-40°C to +120°C, short time +140°C

# Air spring-rate valve (ASV) for multichamber air-springs

Adjusts your setup on the fly

## Customer benefits



- » ASV enables usage of state-of-the-art air-springs
- » Shortest leadtime by pre-developed design
- » Low cost design
- » Pressure euqalization for low leakage



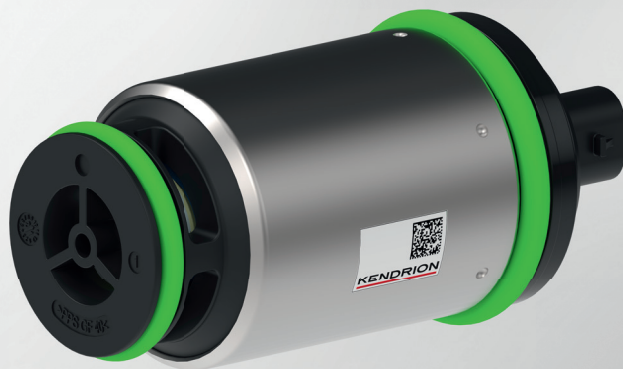

## Valves for multichamber air-springs

**The ultimate solution to get the best out of the air suspension**

Modern suspensions have the ability to adjust the damping force in compression and rebound as well as the chassis height.

New technologies using multi chamber air springs also allow to adjust the spring rate of the air spring on the fly. Therefore air-chambers in the spring are activated or deactivated depending on the driving-setup needed. Our valves coordinate the activation and deactivation of these chambers.

## Technical specifications

**Type**

2/2, NO, Switching

**Control**

PWM, Peak-Hold Current Control, 100 % Duty Cycle, 2 A Peak / 1 A Hold

**Ambient temperature**

-40°C to +100°C

**Operation pressure**

0 to 15 bar (rel)

# Air compressor control unit

combines a very robust, heavy-duty design with very precise electronic control algorithms.

## Customer benefits



### COMPATIBILITY

- » ASIL-B Compatibility
- » LIN | CAN | Autosar communication interface
- » Brushless (BLDC) as well as DC



### SENSOR DATA ANALYSIS

- » Reading and processing of sensor data

### CONTROL POSSIBILITIES

- » Single- and two-piston compressors
- » Highly integrated system incl. ground connection to the motor
- » Sensorless rotor position detection



### ECO MOUNTING OPTIONS

- » Physical separated
- » On air compressor
- » On the valve block





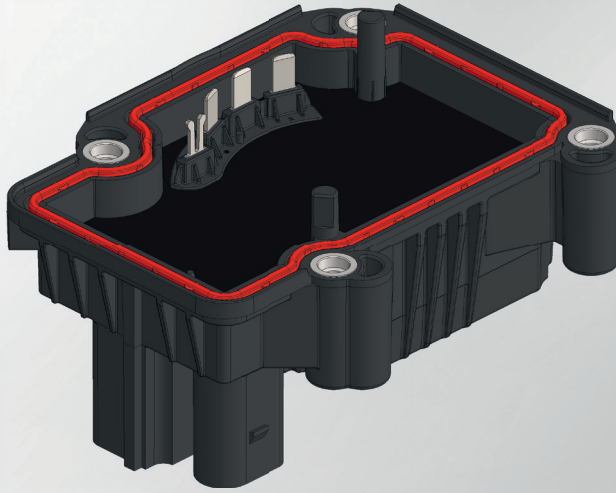

## ECU for air compressor

### Sensorless rotor detection in a robust design

The Air Compressor Control Unit is supposed to control the rounds per minute of a brushless DC motor without using a sensor to detect the rotor position. This leads to a very cost efficient design. The communication via CAN or LIN provides a flexible network integration strategy.

**Type**

**Control**

**Ambient temperature**

**Operating voltage**

**Current range**

**Power Consumption**

Sensorless BLDC Control ECU

CAN, LIN

-40°C to +80°C

9 to 16 V

max. 40 A

up to 500 Watt

# Smart valve block for air chassis applications

ECU and solenoid valve block combined

## Customer benefits

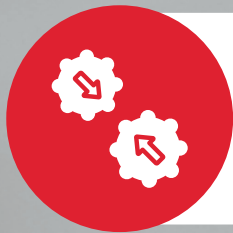

### HIGHLY INTEGRATED

- » Reduced space
- » Reduced weight
- » Reduced costs

### MULTIPLE OPTIONS

- » Solenoid valve block and ECU in one housing or separated
- » Solenoid valve block as stand-alone-solution
- » ECU as stand-alone-solution (previous page)





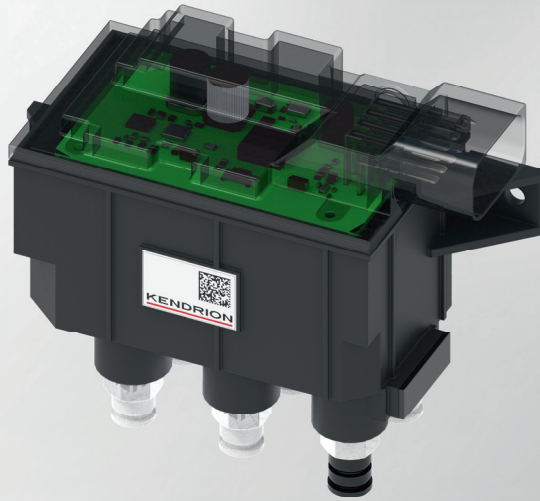

## Smart valve block for air chassis applications

### All in one

ECU for the air compressor and the solenoid valve block are at the core of every air spring system. They are responsible for the control of the overall setting. In combination it enables a compact and competitive solution.

Integration of the ECU in the valveblock enables sensorless position-detection of the valves. In addition, it saves an additional PCB and a housing as this can be easily combined using the already existing PCB in the solenoid valve block!

Kendrion Automotive Group  
marketing-automotive@kendrion.com



[www.kendrion.com](http://www.kendrion.com)

